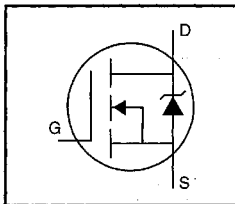


## HEXFET® Power MOSFET

- Dynamic  $dv/dt$  Rating
- Repetitive Avalanche Rated
- 175°C Operating Temperature
- Fast Switching
- Ease of Paralleling
- Simple Drive Requirements



$$V_{DSS} = 100V$$

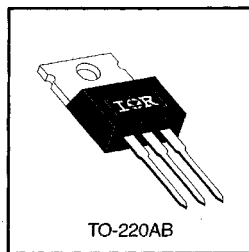
$$R_{DS(on)} = 0.54\Omega$$

$$I_D = 5.6A$$

### Description

Third Generation HEXFETs from International Rectifier provide the designer with the best combination of fast switching, ruggedized device design, low on-resistance and cost-effectiveness.

The TO-220 package is universally preferred for all commercial-industrial applications at power dissipation levels to approximately 50 watts. The low thermal resistance and low package cost of the TO-220 contribute to its wide acceptance throughout the industry.



DATA SHEETS

### Absolute Maximum Ratings

|                           | Parameter  | Max.                | Units |
|---------------------------|--|---------------------|-------|
| $I_D @ T_C = 25^\circ C$  | Continuous Drain Current, $V_{GS} @ 10 V$        | 5.6                 | A     |
| $I_D @ T_C = 100^\circ C$ | Continuous Drain Current, $V_{GS} @ 10 V$        | 4.0                 |       |
| $I_{DM}$                  | Pulsed Drain Current ①                           | 20                  |       |
| $P_D @ T_C = 25^\circ C$  | Power Dissipation                                | 43                  | W     |
|                           | Linear Derating Factor                           | 0.29                | W/°C  |
| $V_{GS}$                  | Gate-to-Source Voltage                           | $\pm 20$            | V     |
| $E_{AS}$                  | Single Pulse Avalanche Energy ②                  | 100                 | mJ    |
| $I_{AR}$                  | Avalanche Current ①                              | 5.6                 | A     |
| $E_{AR}$                  | Repetitive Avalanche Energy ①                    | 4.3                 | mJ    |
| $dv/dt$                   | Peak Diode Recovery $dv/dt$ ③                    | 5.5                 | V/ns  |
| $T_J$                     | Operating Junction and Storage Temperature Range | -55 to +175         | °C    |
| $T_{STG}$                 |  |                     |       |
|                           |  |                     |       |
|                           | Mounting Torque, 6-32 or M3 screw                | 10 lbf·in (1.1 N·m) |       |

### Thermal Resistance

|                 | Parameter                           | Min. | Typ. | Max. | Units |
|-----------------|-------------------------------------|------|------|------|-------|
| $R_{\theta JC}$ | Junction-to-Case                    | —    | —    | 3.5  | °C/W  |
| $R_{\theta CS}$ | Case-to-Sink, Flat, Greased Surface | —    | 0.50 | —    |       |
| $R_{\theta JA}$ | Junction-to-Ambient                 | —    | —    | 62   |       |

## Electrical Characteristics @ T<sub>J</sub> = 25°C (unless otherwise specified)

|  | Parameter                            | Min. | Typ. | Max. | Units | Test Conditions   |
|--|--------------------------------------|------|------|------|-------|---|
| V <sub>(BR)DSS</sub>                   | Drain-to-Source Breakdown Voltage    | 100  | —    | —    | V     | V <sub>GS</sub> =0V, I <sub>D</sub> =250μA                          |
| ΔV <sub>(BR)DSS</sub> /ΔT <sub>J</sub> | Breakdown Voltage Temp. Coefficient  | —    | 0.12 | —    | V/°C  | Reference to 25°C, I <sub>D</sub> =1mA                              |
| R <sub>DS(on)</sub>                    | Static Drain-to-Source On-Resistance | —    | —    | 0.54 | Ω     | V <sub>GS</sub> =10V, I <sub>D</sub> =3.4A ④                        |
| V <sub>GS(th)</sub>                    | Gate Threshold Voltage               | 2.0  | —    | 4.0  | V     | V <sub>DS</sub> =V <sub>GS</sub> , I <sub>D</sub> =250μA            |
| g <sub>fs</sub>                        | Forward Transconductance             | 1.3  | —    | —    | S     | V <sub>DS</sub> =50V, I <sub>D</sub> =3.4A ④                        |
| I <sub>DSS</sub>                       | Drain-to-Source Leakage Current      | —    | —    | 25   | μA    | V <sub>DS</sub> =100V, V <sub>GS</sub> =0V                          |
|  |                                      | —    | —    | 250  | μA    | V <sub>DS</sub> =80V, V <sub>GS</sub> =0V, T <sub>J</sub> =150°C    |
| I <sub>GSS</sub>                       | Gate-to-Source Forward Leakage       | —    | —    | 100  | nA    | V <sub>GS</sub> =20V  |
|  | Gate-to-Source Reverse Leakage       | —    | —    | -100 | nA    | V <sub>GS</sub> =-20V   |
| Q <sub>g</sub>                         | Total Gate Charge                    | —    | —    | 8.3  | nC    | I <sub>D</sub> =5.6A  |
| Q <sub>gs</sub>                        | Gate-to-Source Charge                | —    | —    | 2.3  | nC    | V <sub>DS</sub> =80V  |
| Q <sub>gd</sub>                        | Gate-to-Drain ("Miller") Charge      | —    | —    | 3.8  | nC    | V <sub>GS</sub> =10V See Fig. 6 and 13 ④                            |
| t <sub>d(on)</sub>                     | Turn-On Delay Time                   | —    | 6.9  | —    | ns    | V <sub>DD</sub> =50V  |
| t <sub>r</sub>                         | Rise Time                            | —    | 16   | —    |       | I <sub>D</sub> =5.6A  |
| t <sub>d(off)</sub>                    | Turn-Off Delay Time                  | —    | 15   | —    |       | R <sub>G</sub> =24Ω   |
| t <sub>f</sub>                         | Fall Time                            | —    | 9.4  | —    |       | R <sub>D</sub> =8.4Ω See Figure 10 ④                                |
| L <sub>D</sub>                         | Internal Drain Inductance            | —    | 4.5  | —    | nH    | Between lead, 6 mm (0.25in.) from package and center of die contact |
| L <sub>S</sub>                         | Internal Source Inductance           | —    | 7.5  | —    |       |   |
| C <sub>iss</sub>                       | Input Capacitance                    | —    | 180  | —    | pF    | V <sub>GS</sub> =0V   |
| C <sub>oss</sub>                       | Output Capacitance                   | —    | 81   | —    |       | V <sub>DS</sub> =25V  |
| C <sub>rss</sub>                       | Reverse Transfer Capacitance         | —    | 15   | —    |       | f=1.0MHz See Figure 5   |

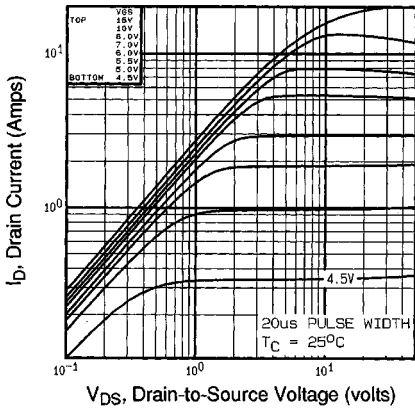


## Source-Drain Ratings and Characteristics

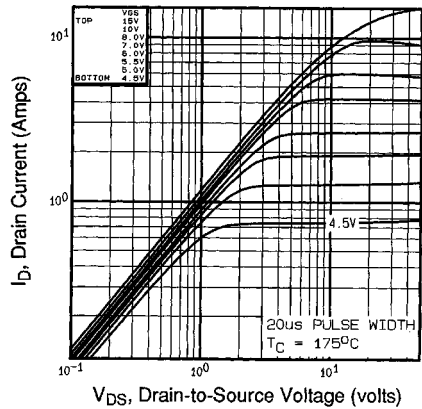
|                 | Parameter                              | Min.   | Typ. | Max. | Units | Test Conditions   |
|-----------------|--|--|------|------|-------|---|
| I <sub>S</sub>  | Continuous Source Current (Body Diode) | —  | —    | 5.6  | A     | MOSFET symbol showing the integral reverse p-n junction diode.    |
| I <sub>SM</sub> | Pulsed Source Current (Body Diode) ①   | —  | —    | 20   |       |   |
| V <sub>SD</sub> | Diode Forward Voltage                  | —  | —    | 2.5  | V     | T <sub>J</sub> =25°C, I <sub>S</sub> =5.6A, V <sub>GS</sub> =0V ④ |
| t <sub>rr</sub> | Reverse Recovery Time                  | —  | 100  | 200  | ns    | T <sub>J</sub> =25°C, I <sub>F</sub> =5.6A                        |
| Q <sub>rr</sub> | Reverse Recovery Charge                | —  | 0.44 | 0.88 | μC    | di/dt=100A/μs ④   |
| t <sub>on</sub> | Forward Turn-On Time                   | intrinsic turn-on time is negligible (turn-on is dominated by L <sub>S</sub> +L <sub>D</sub> ) |      |      |       |   |

### Notes:

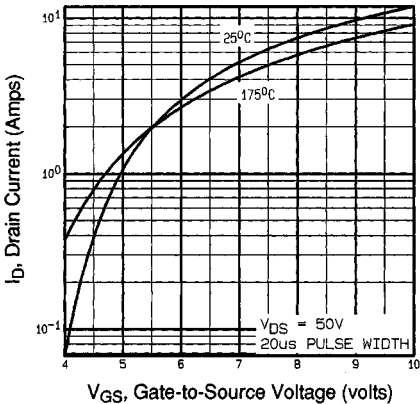
- ① Repetitive rating; pulse width limited by max. junction temperature (See Figure 11)
- ② V<sub>DD</sub>=25V, starting T<sub>J</sub>=25°C, L=4.8mH R<sub>G</sub>=25Ω, I<sub>AS</sub>=5.6A (See Figure 12)
- ③ I<sub>SD</sub>≤5.6A, di/dt≤75A/μs, V<sub>DD</sub>≤V<sub>(BR)DSS</sub>, T<sub>J</sub>≤175°C
- ④ Pulse width ≤ 300 μs; duty cycle ≤2%.



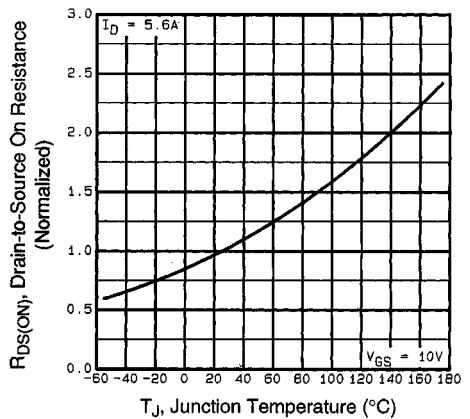
**Fig 1.** Typical Output Characteristics,  
 $T_C=25^\circ\text{C}$



**Fig 2.** Typical Output Characteristics,  
 $T_C=175^\circ\text{C}$

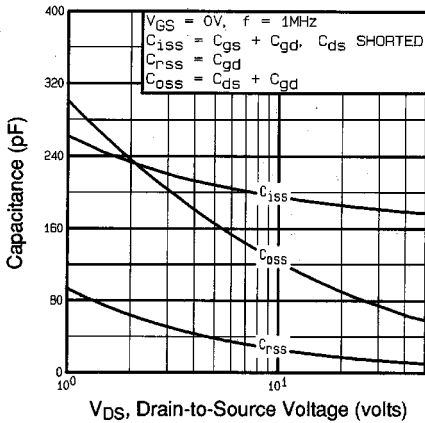


**Fig 3.** Typical Transfer Characteristics

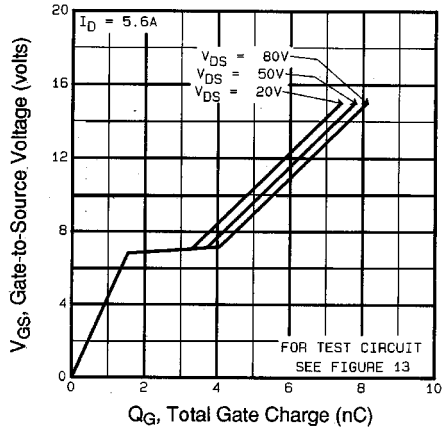


**Fig 4.** Normalized On-Resistance  
Vs. Temperature

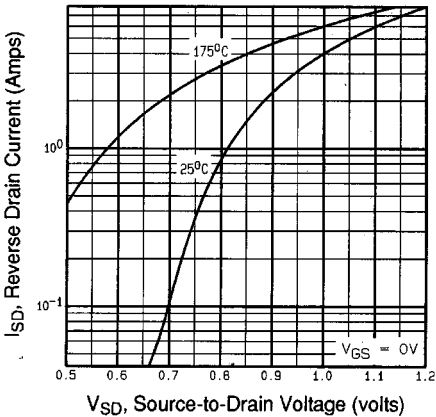
DATA SHEETS



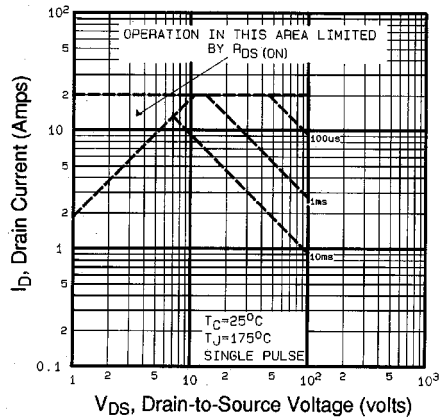
**Fig 5.** Typical Capacitance Vs. Drain-to-Source Voltage



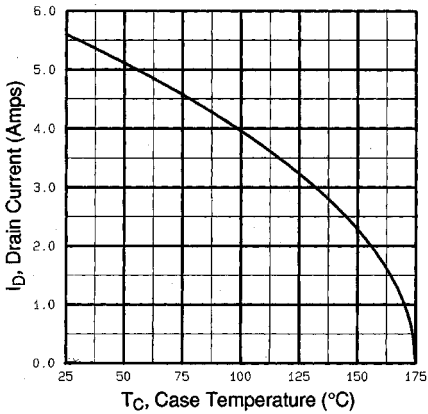
**Fig 6.** Typical Gate Charge Vs. Gate-to-Source Voltage



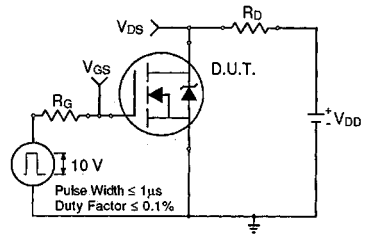
**Fig 7.** Typical Source-Drain Diode Forward Voltage



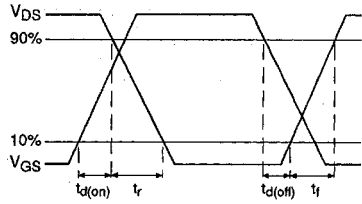
**Fig 8.** Maximum Safe Operating Area



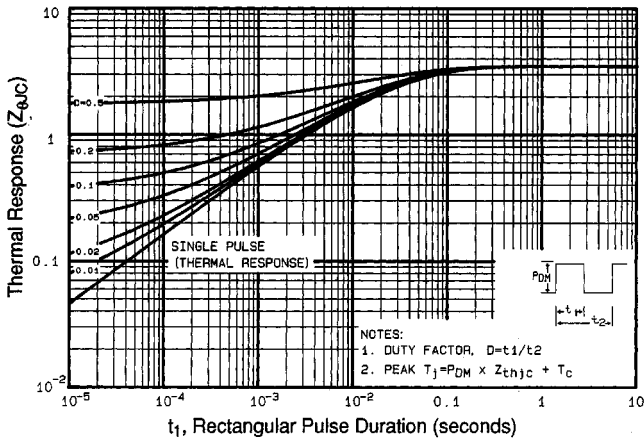
**Fig 9.** Maximum Drain Current Vs. Case Temperature



**Fig 10a.** Switching Time Test Circuit

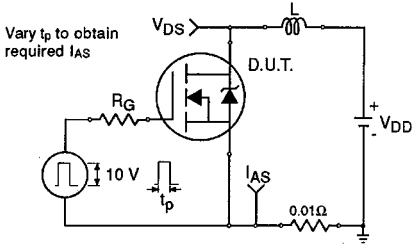


**Fig 10b.** Switching Time Waveforms

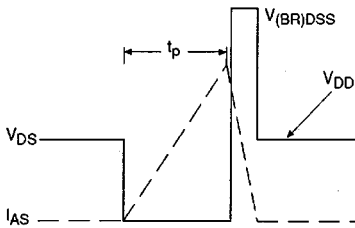


**Fig 11.** Maximum Effective Transient Thermal Impedance, Junction-to-Case

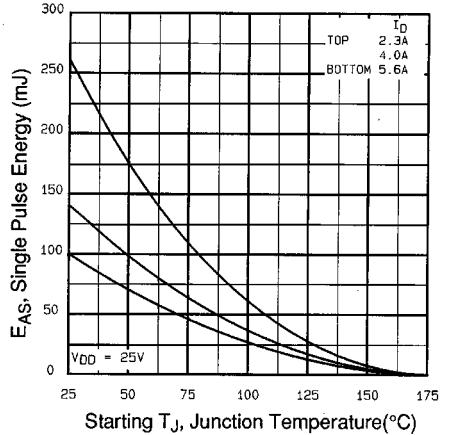
DATA SHEETS



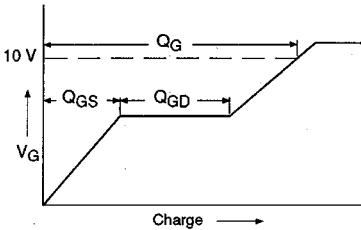
**Fig 12a.** Unclamped Inductive Test Circuit



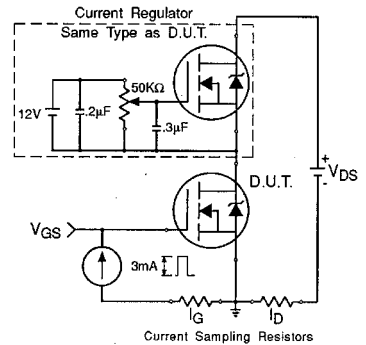
**Fig 12b.** Unclamped Inductive Waveforms



**Fig 12c.** Maximum Avalanche Energy Vs. Drain Current



**Fig 13a.** Basic Gate Charge Waveform



**Fig 13b.** Gate Charge Test Circuit

**Appendix A:** Figure 14, Peak Diode Recovery  $dv/dt$  Test Circuit – See page 1505

**Appendix B:** Package Outline Mechanical Drawing – See page 1509

**Appendix C:** Part Marking Information – See page 1516

**Appendix E:** Optional Leadforms – See page 1525

This datasheet has been download from:

[www.datasheetcatalog.com](http://www.datasheetcatalog.com)

Datasheets for electronics components.